

# MITSUBISHI RF POWER TRANSISTOR 2SC1968

## NPN EPITAXIAL PLANAR TYPE

### DESCRIPTION

2SC1968 is a silicon NPN epitaxial planar type transistor designed for RF power amplifiers on UHF band mobile radio applications.

### FEATURES

- High power gain:  $G_{pe} \geq 3.7\text{dB}$   
@  $V_{CC} = 13.5\text{V}$ ,  $P_O = 14\text{W}$ ,  $f = 470\text{MHz}$
- Emitter ballasted construction and gold metallization for high reliability and good performances.
- Low thermal resistance ceramic package with flange.
- Ability of withstanding more than 20:1 load VSWR all phase when operated at  $V_{CC} = 15.2\text{V}$ ,  $P_O = 18\text{W}$ ,  $f = 470\text{MHz}$ .

### APPLICATION

10 to 14 watts output power amplifiers in UHF band mobile radio applications.

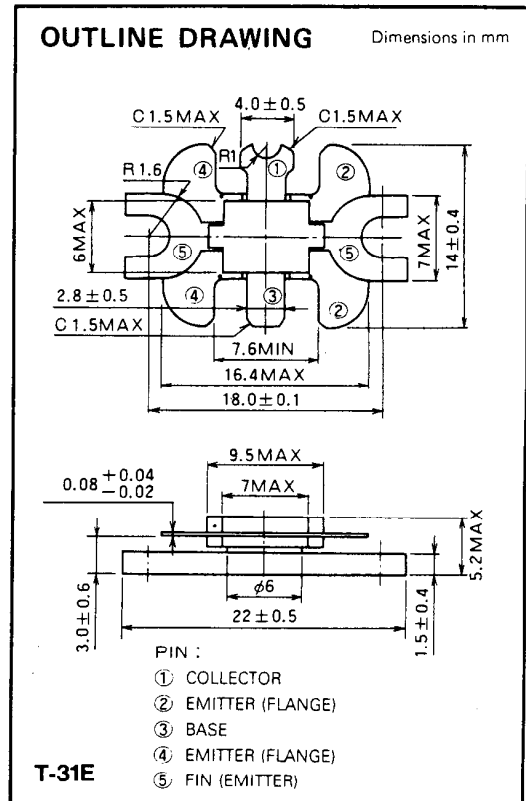

### ABSOLUTE MAXIMUM RATINGS ( $T_C = 25^\circ\text{C}$ unless otherwise specified)

Symbol	Parameter	Conditions	Ratings	Unit
$V_{CB0}$	Collector to base voltage		35	V
$V_{EB0}$	Emitter to base voltage		4	V
$V_{CE0}$	Collector to emitter voltage	$R_{BE} = \infty$	17	V
$I_C$	Collector current		5	A
$P_C$	Collector dissipation	$T_a = 25^\circ\text{C}$	3	W
		$T_C = 25^\circ\text{C}$	40	W
$T_j$	Junction temperature		175	$^\circ\text{C}$
$T_{stg}$	Storage temperature		-65 to 175	$^\circ\text{C}$
$R_{th-a}$	Thermal resistance	Junction to ambient	50	$^\circ\text{C}/\text{W}$
$R_{th-c}$		Junction to case	3.75	$^\circ\text{C}/\text{W}$

Note. Above parameters are guaranteed independently.

### ELECTRICAL CHARACTERISTICS ( $T_C = 25^\circ\text{C}$ unless otherwise specified)

Symbol	Parameter	Test conditions	Limits			Unit
			Min	Typ	Max	
$V_{(BR)EBO}$	Emitter to base breakdown voltage	$I_E = 10\text{mA}$ , $I_C = 0$	4			V
$V_{(BR)CB0}$	Collector to base breakdown voltage	$I_C = 10\text{mA}$ , $I_E = 0$	35			V
$V_{(BR)CE0}$	Collector to emitter breakdown voltage	$I_C = 50\text{mA}$ , $R_{BE} = \infty$	17			V
$I_{CBO}$	Collector cutoff current	$V_{CB} = 15\text{V}$ , $I_E = 0$			500	$\mu\text{A}$
$I_{EBO}$	Emitter cutoff current	$V_{EB} = 2\text{V}$ , $I_C = 0$			400	$\mu\text{A}$
$h_{FE}$	DC forward current gain *	$V_{CE} = 10\text{V}$ , $I_C = 0.1\text{A}$	10	50	180	—
$P_O$	Output power	$V_{CC} = 13.5\text{V}$ , $P_{in} = 6\text{W}$ , $f = 470\text{MHz}$	14	16		W
$\eta_C$	Collector efficiency		50	60		%

Note. \* Pulse test,  $P_w = 150\mu\text{s}$ , duty=5%.

Above parameters, ratings, limits and conditions are subject to change.

NOV. '97

**TEST CIRCUIT**

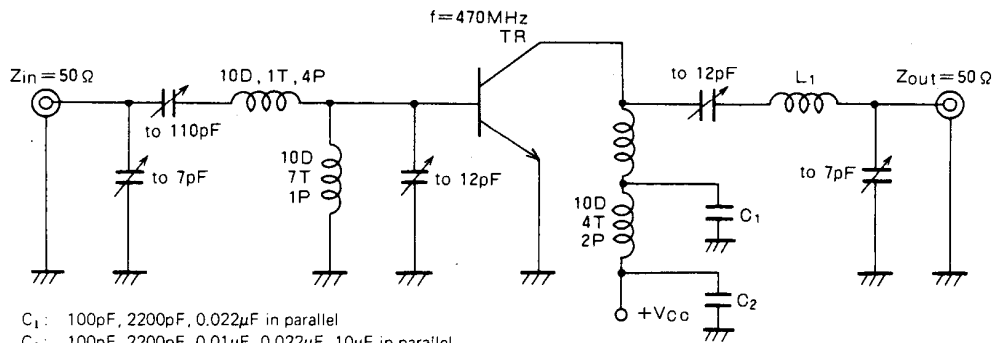

- C<sub>1</sub>: 100pF, 2200pF, 0.022μF in parallel
- C<sub>2</sub>: 100pF, 2200pF, 0.01μF, 0.022μF, 10μF in parallel
- L<sub>1</sub>: Length 4mm, width 8mm, thickness 0.3mm copper plate
- Notes: All coils are made from 1.5 mmφ silver plated copper wire except L<sub>1</sub>  
 Coil dimensions in milli-meter  
 D: inner diameter of coil  
 T: Turn number of coil  
 P: Pitch of coil

**TYPICAL PERFORMANCE DATA**

**COLLECTOR DISSIPATION VS. AMBIENT TEMPERATURE**

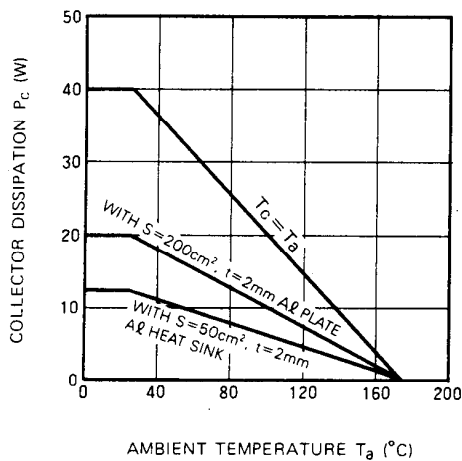

**COLLECTOR CURRENT VS. COLLECTOR TO EMITTER VOLTAGE**

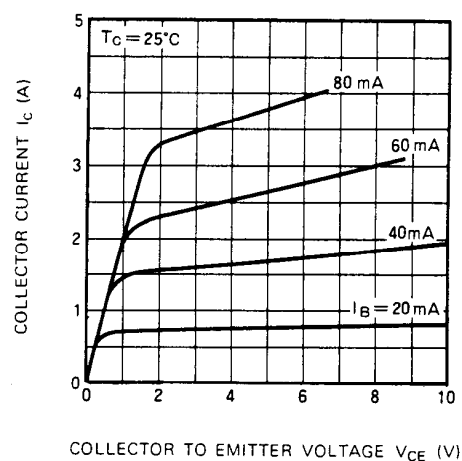

**DC CURRENT GAIN VS. COLLECTOR CURRENT**

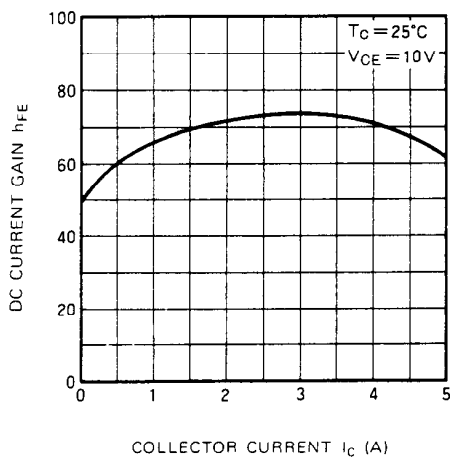

**COLLECTOR TO EMITTER BREAKDOWN VOLTAGE VS. BASE TO EMITTER RESISTANCE**

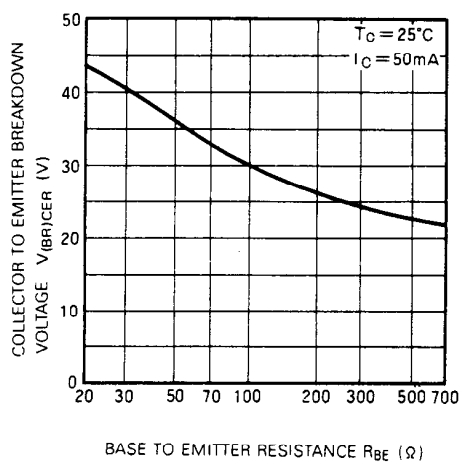

**COLLECTOR OUTPUT CAPACITANCE VS. COLLECTOR TO BASE VOLTAGE**

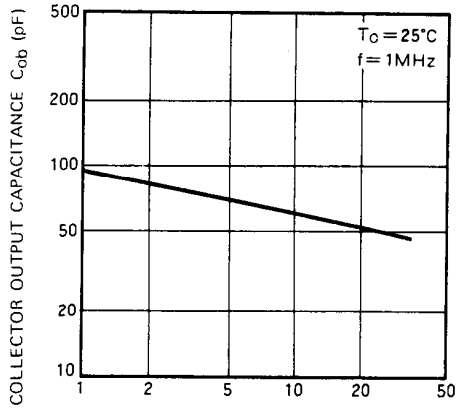

COLLECTOR TO BASE VOLTAGE  $V_{CB}$  (V)

**OUTPUT POWER, COLLECTOR EFFICIENCY VS. INPUT POWER**

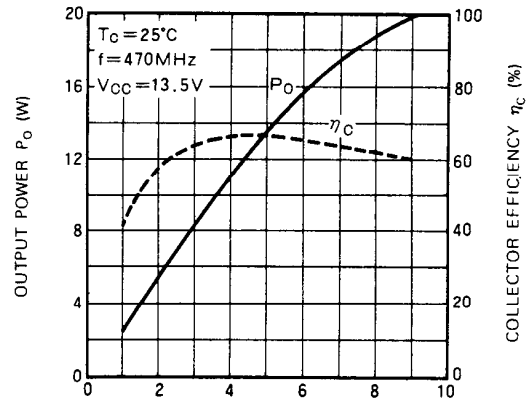

INPUT POWER  $P_{in}$  (W)

**OUTPUT POWER VS. COLLECTOR SUPPLY VOLTAGE**

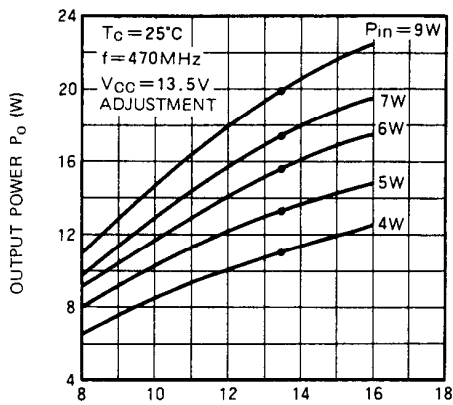

COLLECTOR SUPPLY VOLTAGE  $V_{CC}$  (V)

This datasheet has been download from:

[www.datasheetcatalog.com](http://www.datasheetcatalog.com)

Datasheets for electronics components.